



T&S BRASS AND BRONZE WORKS, INC.  
 2 SADDLEBACK COVE / P.O. BOX 1088 / TRAVELERS REST, SC 29690  
 PHONE 800-476-4103 - FAX 864- 834-3518



Sales No.

000813-25

RELIABILITY  
 BUILT IN

Job Name:

Architect/Engineer Approval:

Notes:

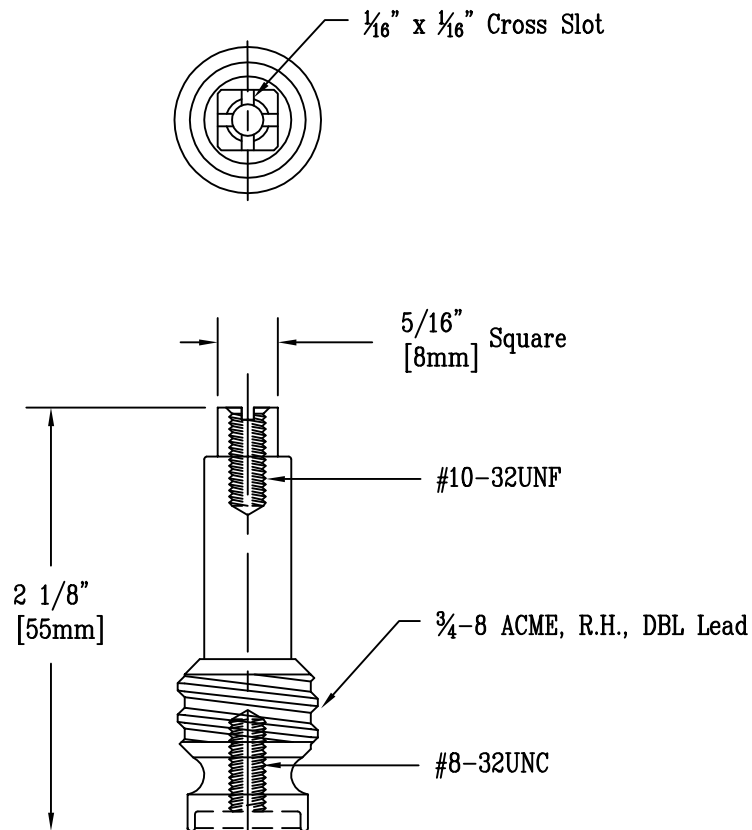

Finish: Chrome Plated

Product Description:

Spindle, 124A

Drawn:

DHL

Approved

JHB

Checked

MAV

Scale:

1:1

Date:

04/25/07