

This Space For Architect/Engineer Approval

Job Name \_\_\_\_\_ Date \_\_\_\_\_  
 Model Specified \_\_\_\_\_ Quantity \_\_\_\_\_  
 Customer/Wholesaler \_\_\_\_\_  
 Contractor \_\_\_\_\_  
 Architect/Engineer \_\_\_\_\_

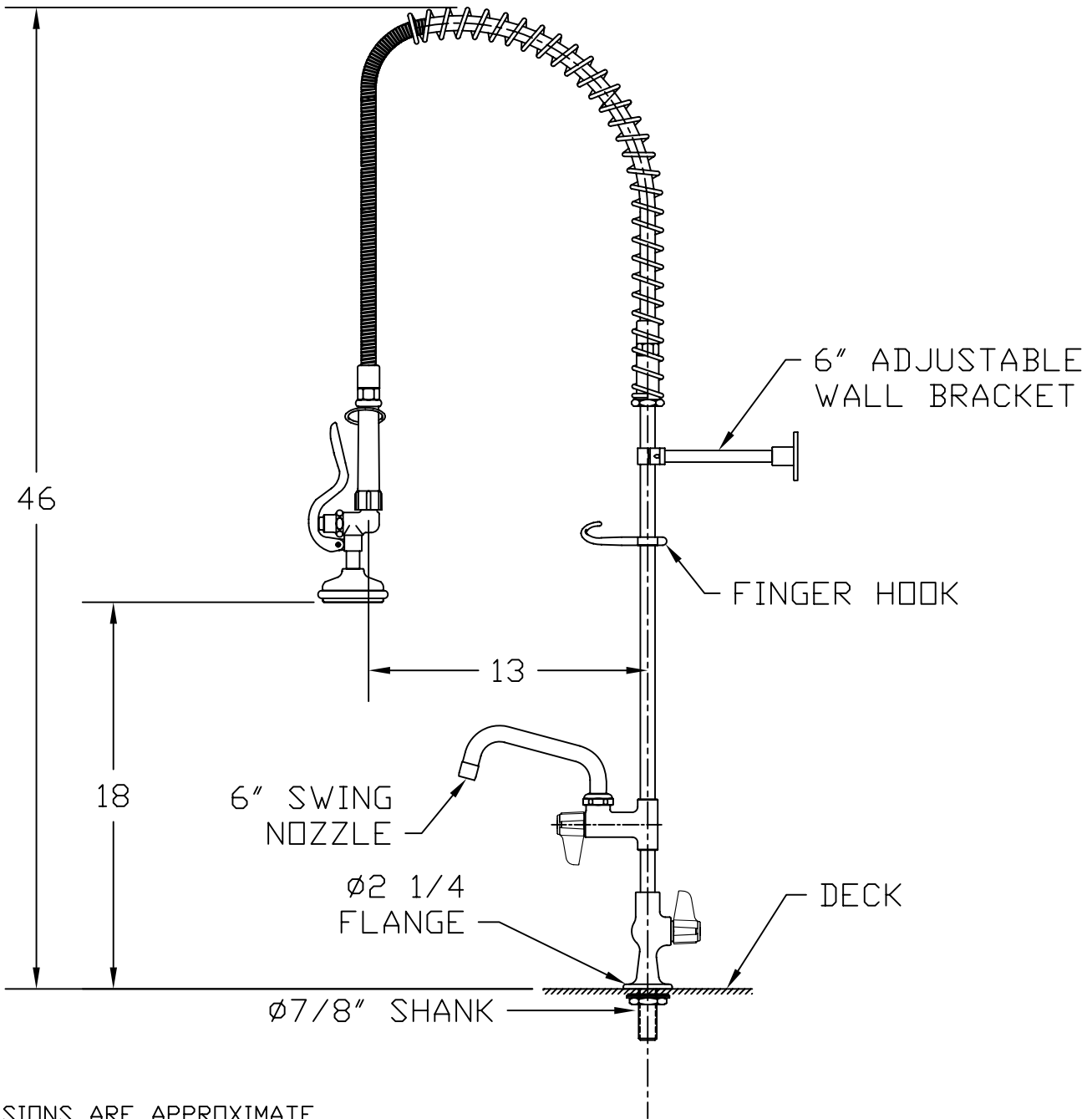

DIMENSIONS ARE APPROXIMATE

MODEL NUMBER 5PR-1S06	DATE 3/21/06	SCALE 1:8	DRAWN DHL	CHECKED WJS	APPROVED JHB
--------------------------	-----------------	--------------	--------------	----------------	-----------------



DESCRIPTION

SINGLE SUPPLY DECK MOUNT PRU  
 w/ 6" SWING NOZZLE ADD-ON FAUCET

equip Foodservice Accessories  
 P.O. BOX 1088, 2 SADDLEBACK COVE  
 TRAVELERS REST, SOUTH CAROLINA 29690  
 PHONE: 800.891.4808 FAX: 800.868.0084