



T&S BRASS AND BRONZE WORKS, INC.

2 SADDLEBACK COVE / P.O. BOX 1088 / TRAVELERS REST, SC 29690

PHONE 800-476-4103

FAX 864-834-3518



REG.#A2601
ISO #9001

Model No.

B-7242-C08H

Item No.:

Job Name:

Architect/Engineer Approval:

Notes:

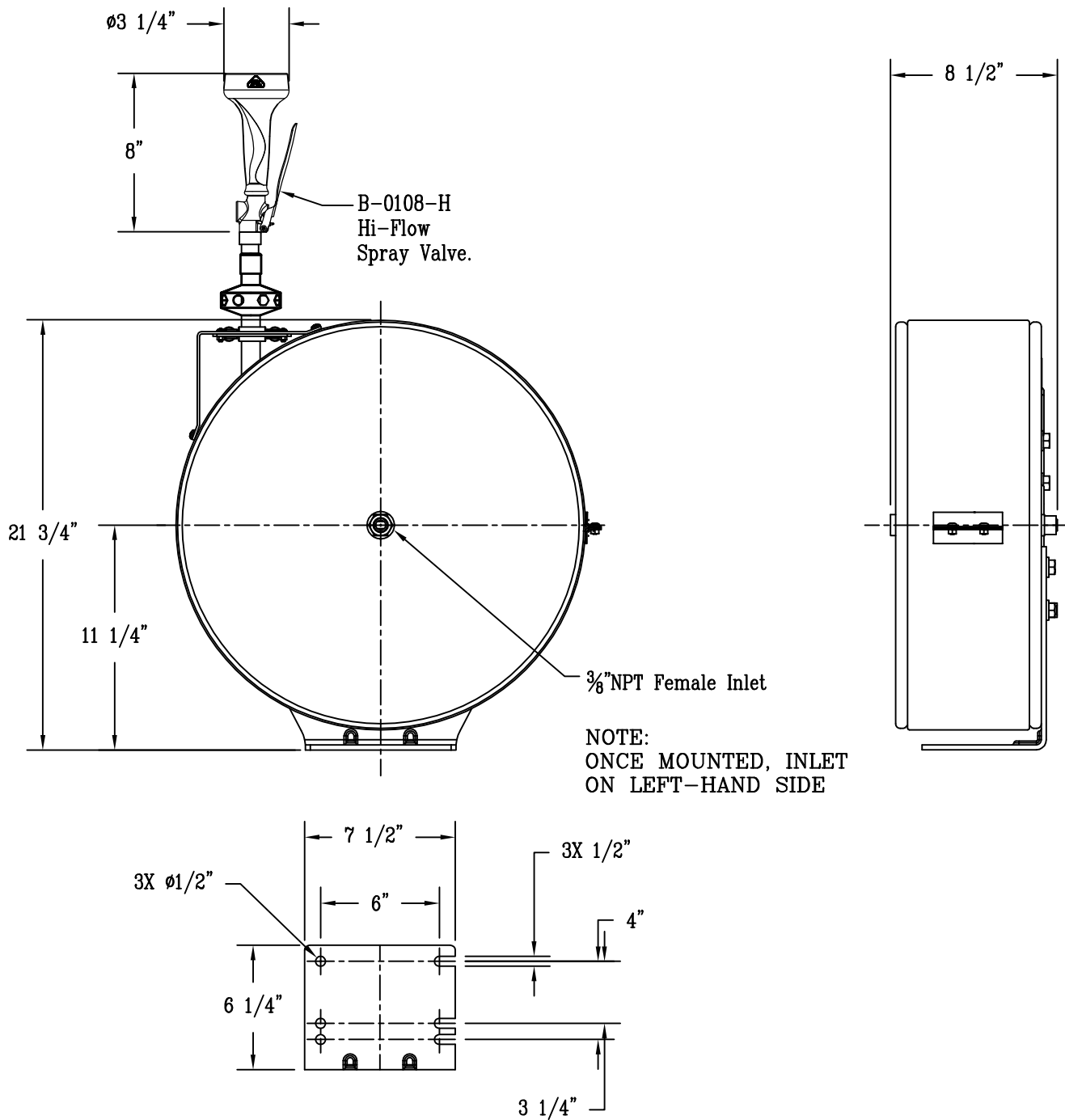

Product Description:
Hose Reel: Closed, Epoxy Powder Coated Steel,
50 FT OF 3/8 Dia. Blue Hose and
Hi-Flow Spray Valve

Drawn:

WJS

Checked

JRM

Scale:

1 : 8

Approved

JHB

Date:

05/18/06