

T&S BRASS AND BRONZE WORKS, INC.  
 2 SADDLEBACK COVE / P.O. BOX 1088 / TRAVELERS REST, SC 29690  
 PHONE 800-476-4103 FAX 864- 834-3518



Model No.

BL-4100-0

Item No.:

REG.#A2601  
 ISO #9002

Job Name:

Architect/Engineer Approval:

Notes:

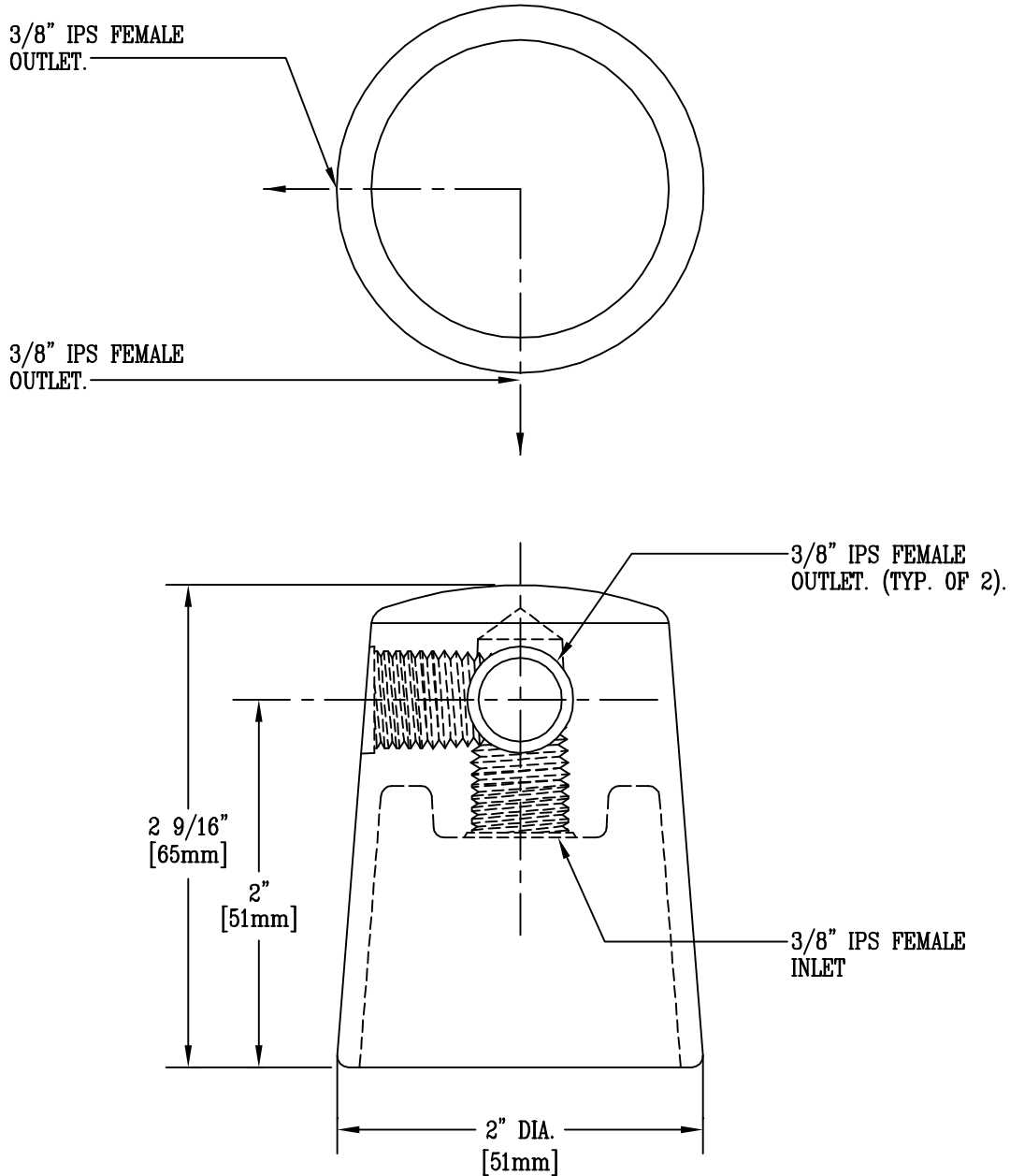

Product Description:

GAS TURRET WITH (2) 90 DEGREE SIDE OUTLETS

Drawn:

WJS

Approved

CA

Checked

ARY

Scale:

1' = 1'

Date:

10/2/95