

This Space for Architect/Engineer Approval

Job Name _____ Date _____

Model Specified _____ Quantity _____

Customer/Wholesaler _____

Contractor _____

Architect _____

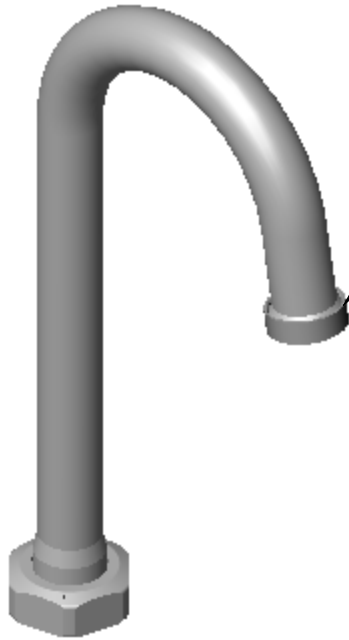

13/16-24 MALE THREAD
CONCEALED BY PLAIN-END
SPOUT RING

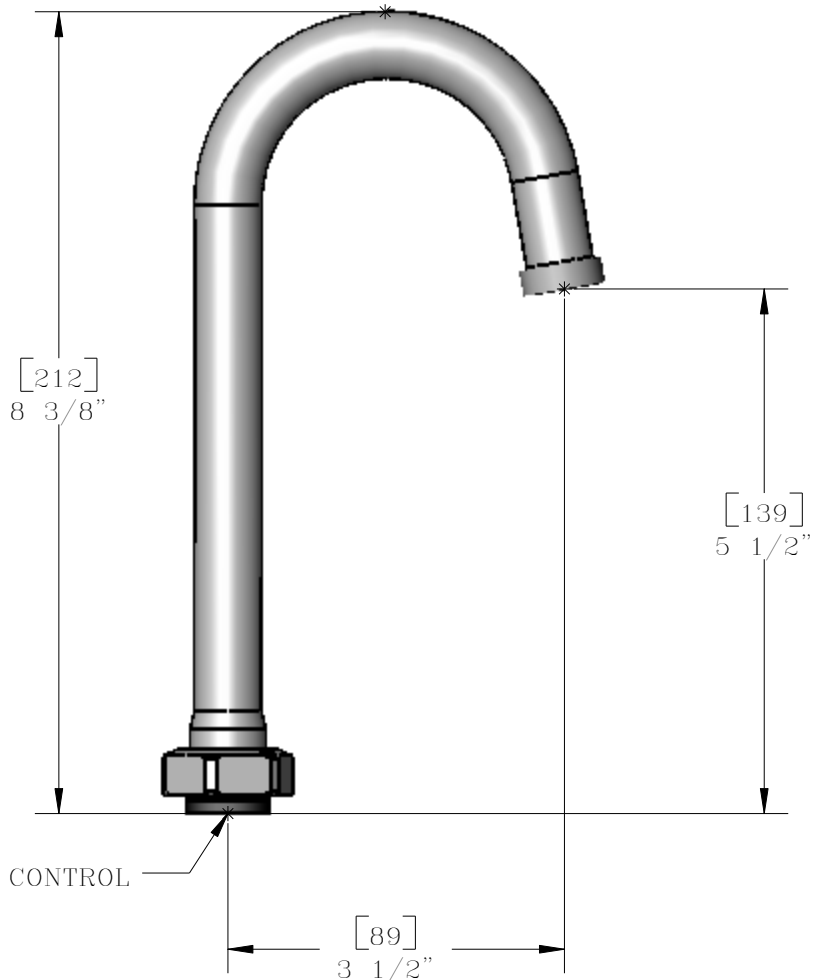

Model Number
Q016236-40

Date
8/14/06

Scale
1:2

Drawn
DHL

Checked
JRM

Approved
JHB



Product Specifications:

3 1/2" (GN-A) Gooseneck, Plain End
w/ 2.0 GPM Flow Control



T&S BRASS AND BRONZE WORKS, INC.
2 Saddleback Cove, P.O. Box 1088
Travelers Rest, South Carolina 29690

Phone: 800.476.4103 Fax: 800.834.3518, Simi Valley 800.423.0750



REG. #A2601
ISO #9001