



T&S BRASS AND BRONZE WORKS, INC.
 2 Saddleback Cove / P.O. Box 1088
 Travelers Rest, SC 29690



REG. #A2601
 ISO #9001

Model No.
014935-45

Item No.

Travelers Rest, SC: 800-476-4103 Simi Valley, CA: 800-423-0150 Fax: 864-834-3518 www.tsbrass.com

This Space for Architect/Engineer Approval

Job Name _____ Date _____

Model Specified _____ Quantity _____

Customer/Wholesaler _____

Contractor _____

Architect/Engineer _____

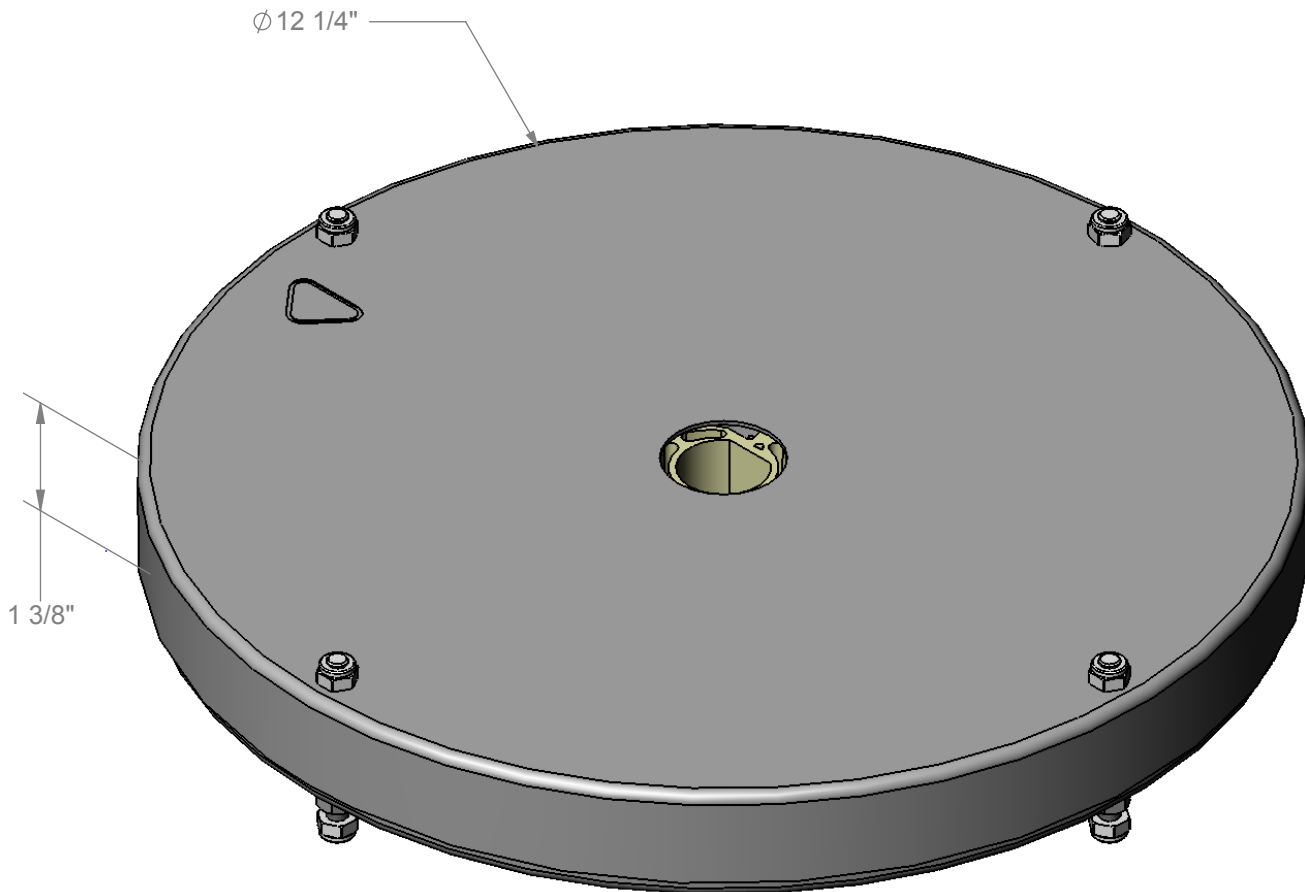

Product Specifications:
**Spring Assembly Kit
 For Large Diameter
 Stainless Steel Hose Reel**

Drawn JRM	Checked GEF	Approved JHB
Scale: 1:2	Date: 10/26/07	