

This Space For Architect/Engineer Approval

Job Name _____ Date _____
 Model Specified _____ Quantity _____
 Customer/Wholesaler _____
 Contractor _____
 Architect/Engineer _____

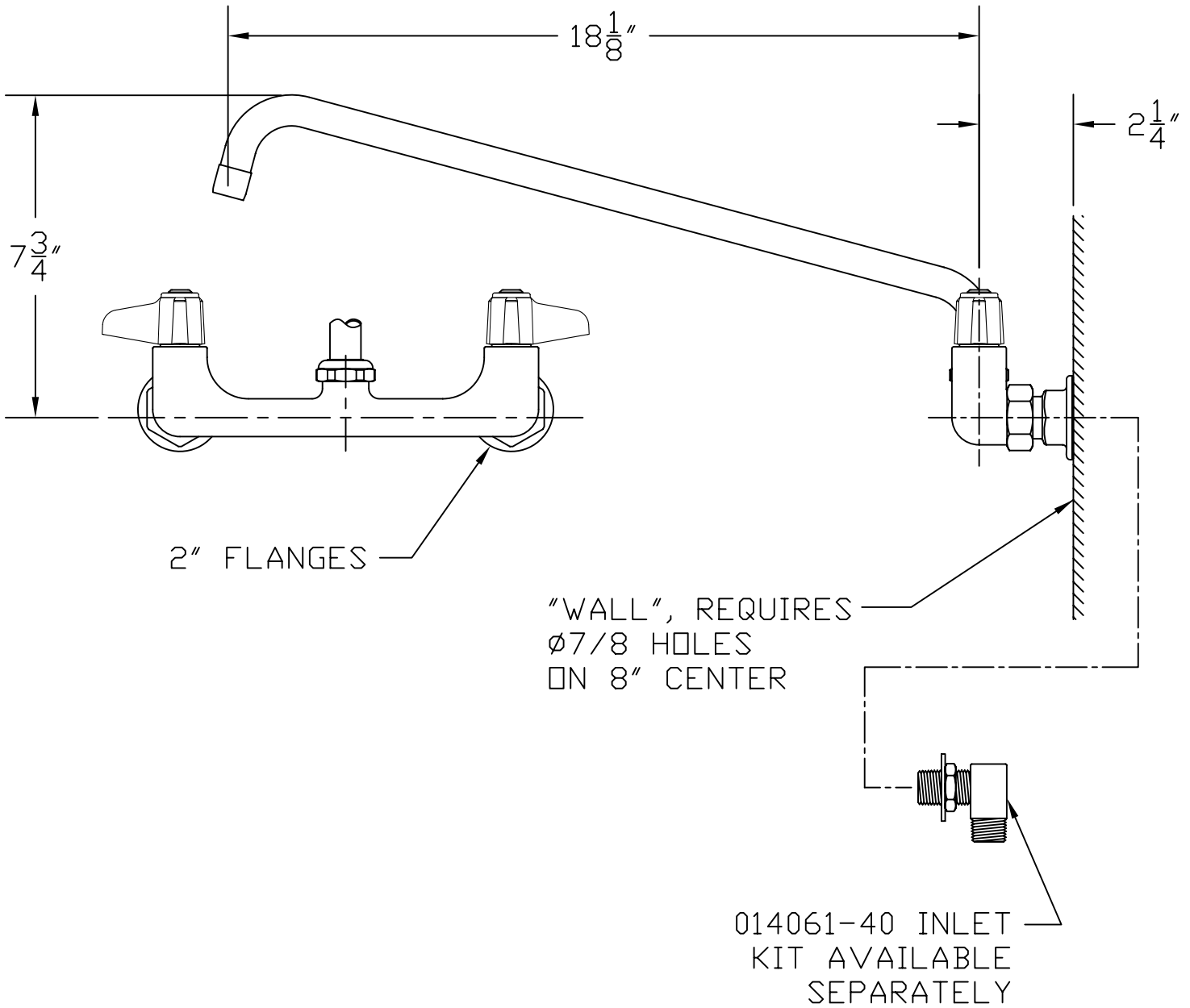

DIMENSIONS ARE APPROXIMATE

MODEL NUMBER 5F-8WLX18	DATE 3/21/06	SCALE 1:4	DRAWN DHL	CHECKED WJS	APPROVED JHB
---------------------------	-----------------	--------------	--------------	----------------	-----------------



DESCRIPTION

8" WALL MOUNT FAUCET
 WITH 18" SWING NOZZLE

equip Foodservice Accessories
 P.O. BOX 1088, 2 SADDLEBACK COVE
 TRAVELERS REST, SOUTH CAROLINA 29690
 PHONE: 800.891.4808 FAX: 800.868.0084