



T&S BRASS AND BRONZE WORKS, INC.

2 SADDLEBACK COVE / P.O. BOX 1088 / TRAVELERS REST, SC 29690

PHONE 800-476-4103

FAX 864- 834-3518



REG.#A2601
ISO #9002

Model No.

B-0682-ST

Item No.:

Job Name:

Architect/Engineer Approval:

Notes:



ADA COMPLIANT

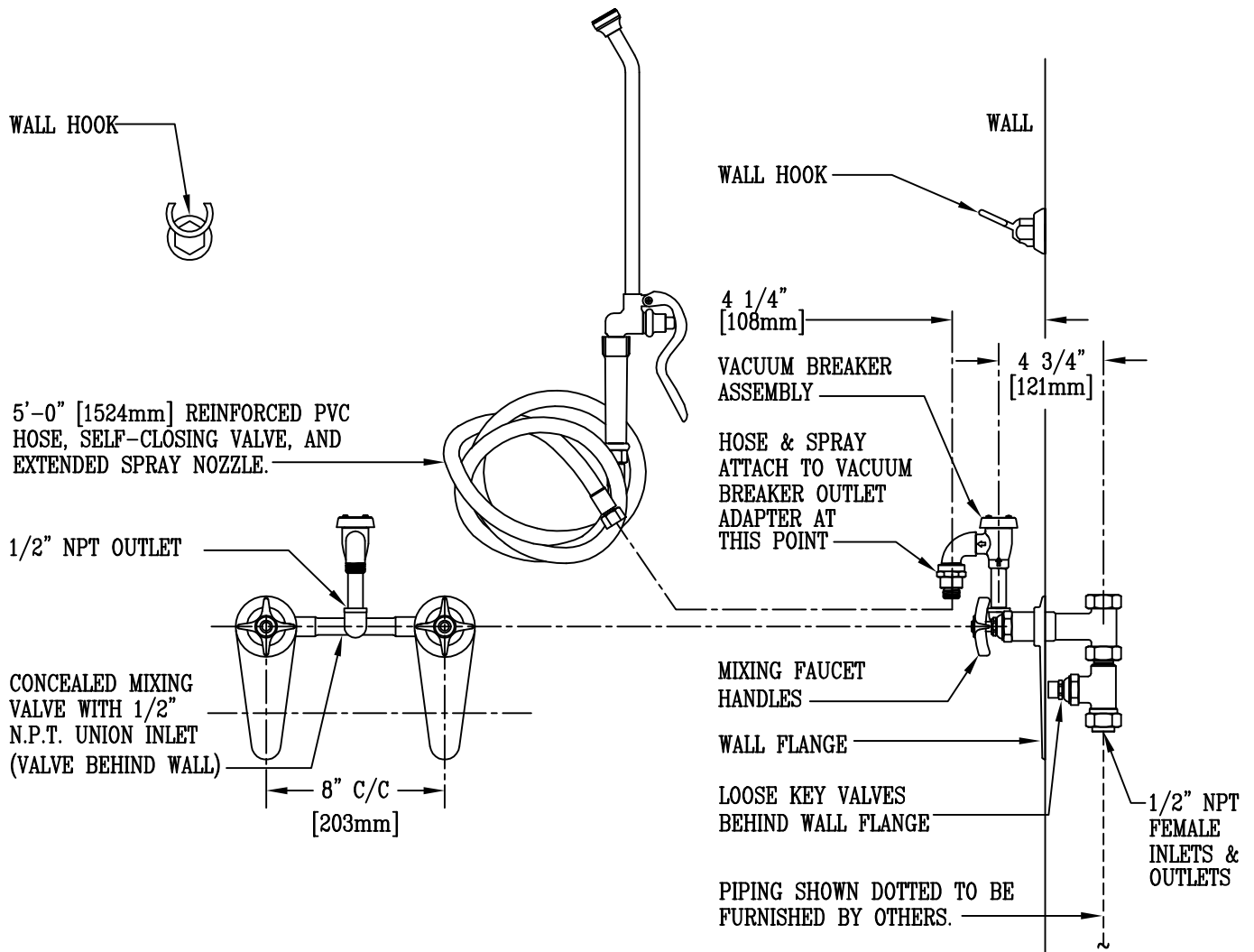

Product Description:

BED PAN WASHER WITH MIXING FAUCET, INTEGRAL LOOSE KEY STOPS, VACUUM BREAKER, & SELF-CLOSING VALVE W/ EXTENDED SPRAY OUTLET

Drawn:

DHL

Checked

GEF

Scale:

1:8

Approved

JHB

Date:

09/18/06