



**T&S BRASS AND BRONZE WORKS, INC.**  
 2 SADDLEBACK COVE / P.O. BOX 1088 / TRAVELERS REST, SC 29690  
 PHONE 800-476-4103 - FAX 864- 834-3518



Model No.

B-1102

**RELIABILITY  
BUILT IN**

Job Name:

Architect/Engineer Approval:

Notes:

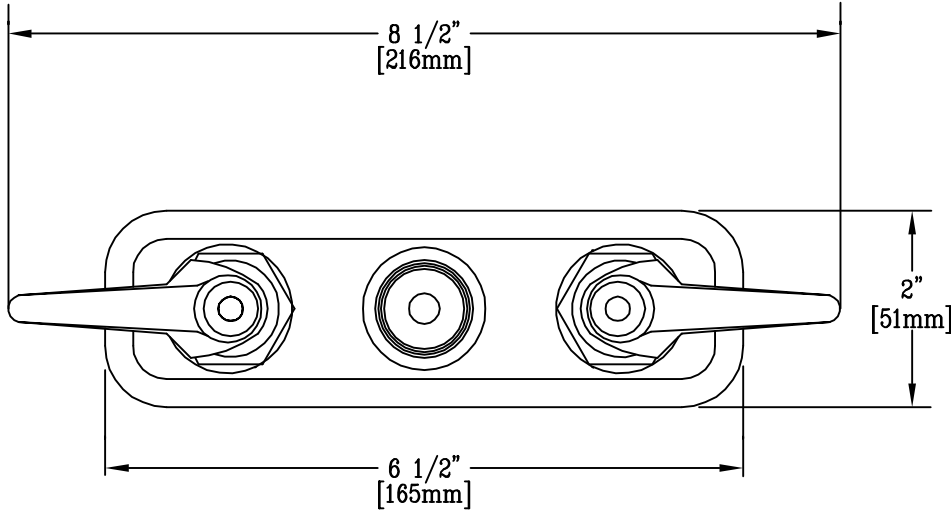

TOP VIEW

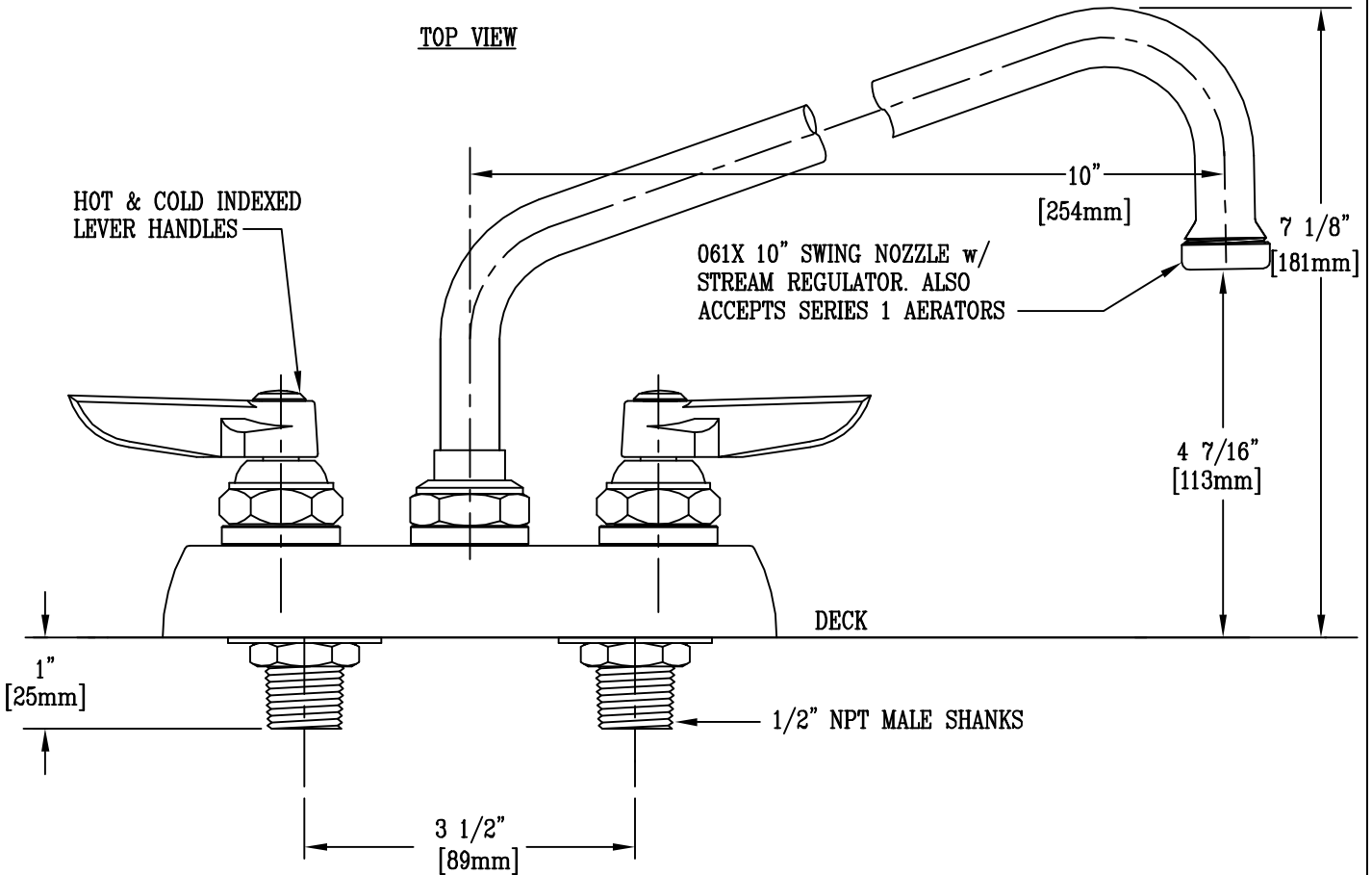

Product Description:  
 WORKBOARD FAUCET WITH 1/2" NPT MALE SHANKS,  
 3 1/2" INLET CENTERS, 061X 10" SWING NOZZLE,  
 STREAM REGULATOR, LEVER HANDLES

Drawn:

WJS

Checked

JKD

Scale:

1 : 2

Approved

MVW

Date:

9-14-01