



T&S BRASS AND BRONZE WORKS, INC.
 2 SADDLEBACK COVE / P.O. BOX 1088 / TRAVELERS REST, SC 29690
 PHONE 800-476-4103 - FAX 864- 834-3518



Model No.

B-1120-XS

**RELIABILITY
BUILT IN**

Job Name:

Architect/Engineer Approval:

Notes:

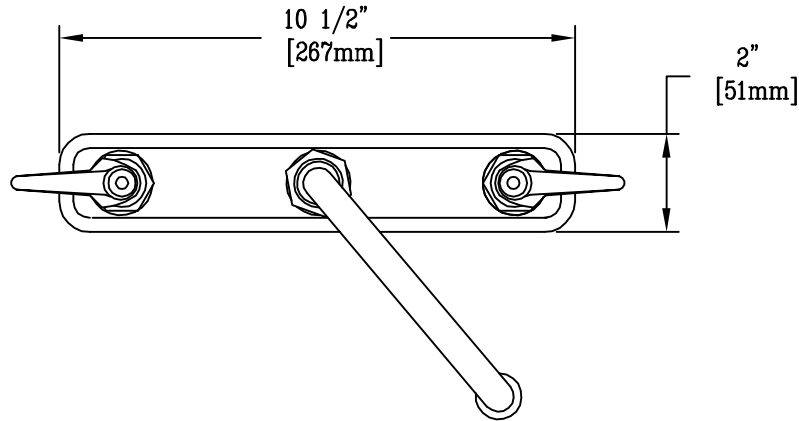

TOP VIEW

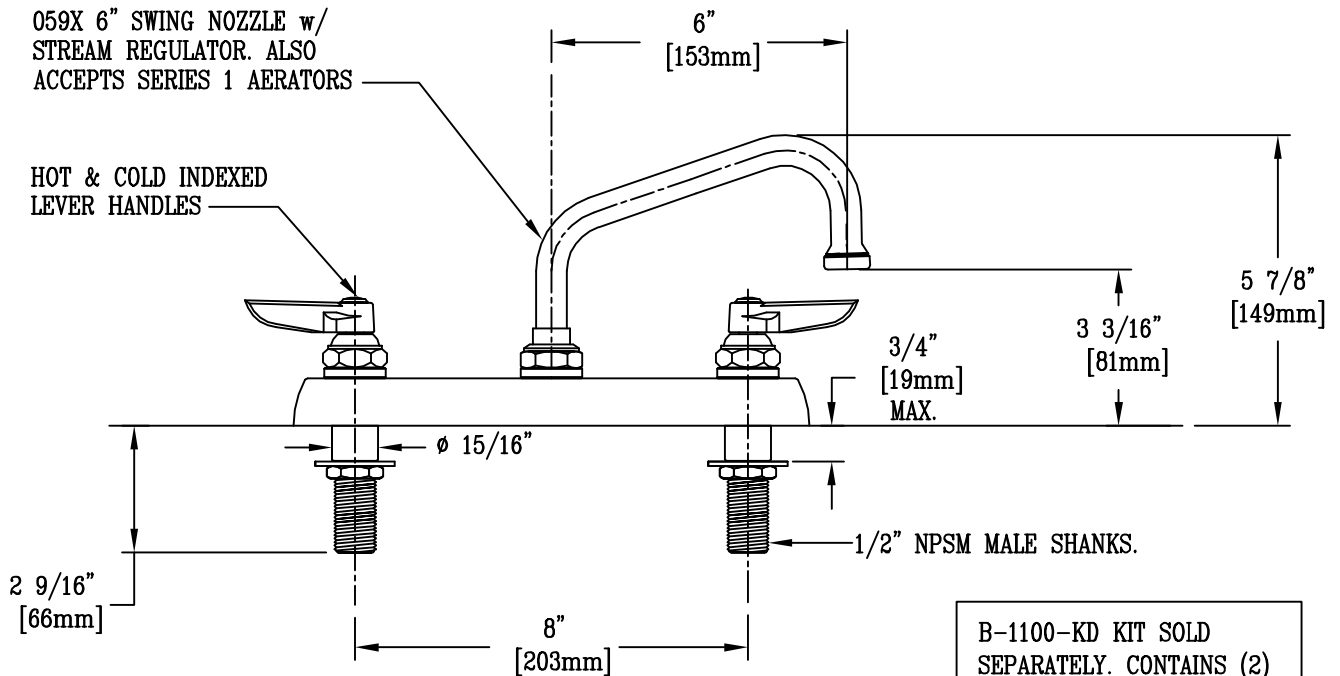

FRONT VIEW

Product Description:
 WORKBOARD FAUCET WITH 1/2" NPSM MALE EXTENDED SHANKS,
 8" INLET CENTERS, 059X 6" SWING NOZZLE,
 STREAM REGULATOR, LEVER HANDLES

Drawn:

WJS

Checked

JKD

Scale:

1 : 4

Approved

MVW

Date:

10-4-01