



T&S BRASS AND BRONZE WORKS, INC.

2 SADDLEBACK COVE / P.O. BOX 1088 / TRAVELERS REST, SC 29690

PHONE 800-476-4103

FAX 864-834-3518



REG.#A2601
ISO #9001

Model No.

B-7133-05

Item No.:

Job Name:

Architect/Engineer Approval:

Notes:

MV-2522-24 FRONT TRIGGER STYLE GUN
WITH RETRACTABLE HOLD DOWN CLIP,
STAINLESS STEEL BODY AND ROYAL
BLUE RUBBER COVER

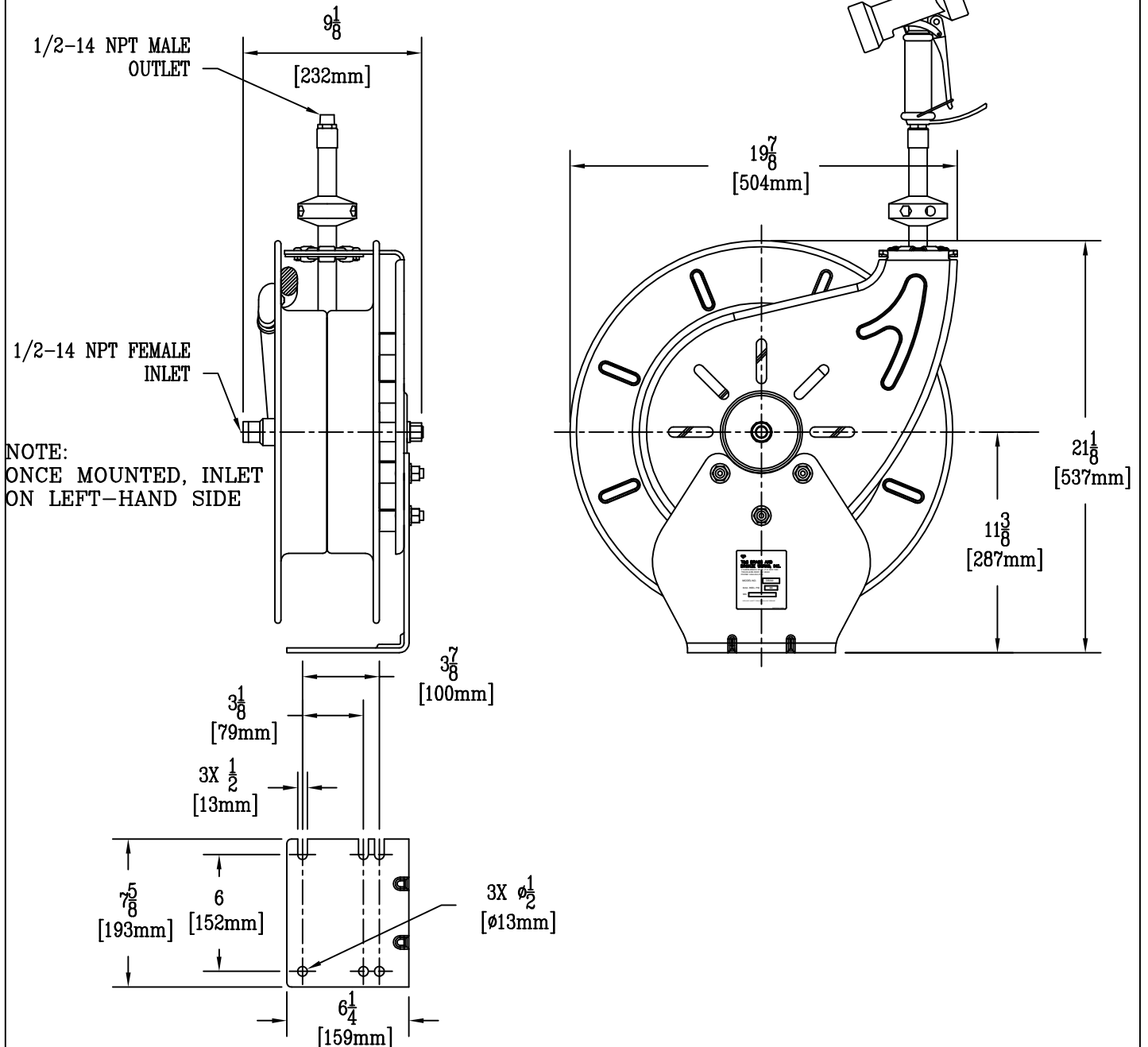

Product Description:

HOSEREEL, OPEN, STAINLESS STEEL
35 FT OF 1/2 DIA. BLUE HOSE AND
MV-2522-24 FRONT TRIGGER, 5/16" SPRAY GUN

Drawn:

JRM

Checked:

JHB

Scale:

1 : 8

Approved:

JHB

Date:

6/9/05