



T&S BRASS AND BRONZE WORKS, INC.
 2 SADDLEBACK COVE / P.O. BOX 1088 / TRAVELERS REST, SC 29690
 PHONE 800-476-4103 FAX 864- 834-3518



Model No.
 BL-9000-11
 Item No.:

Job Name:

Architect/Engineer Approval:

Notes:

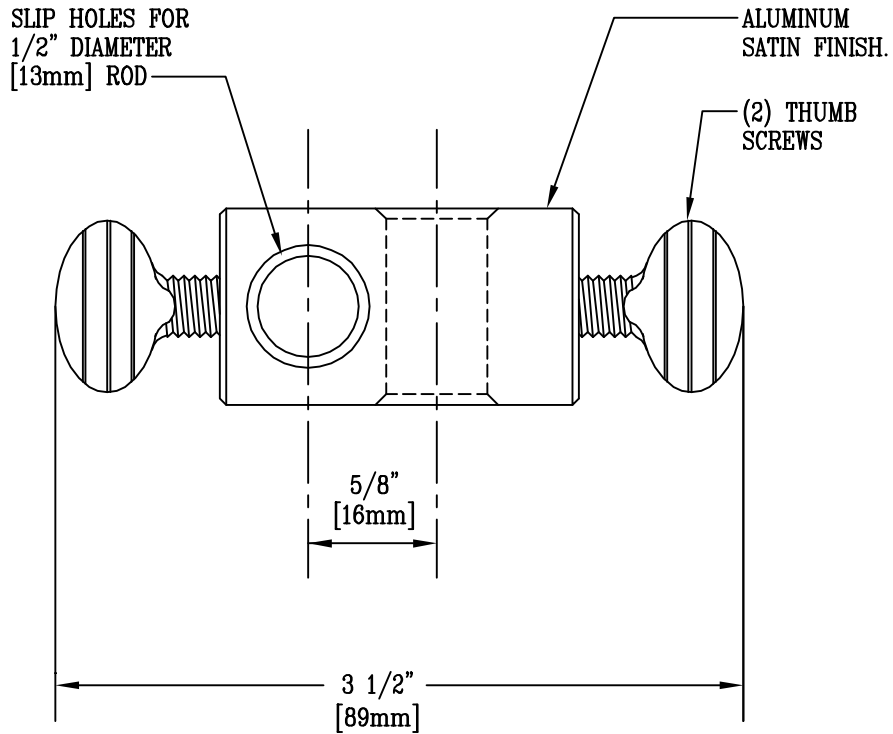

Product Description:

CLAMP FOR 1/2" DIAMETER ROD

Drawn:

WJS

Approved

CA

Checked

MWR

Scale:

1' = 1'

Date:

10/11/95