

This Space for Architect/Engineer Approval

Job Name _____ Date _____
Model Specified _____ Quantity _____
Customer/Wholesaler _____
Contractor _____
Architect _____

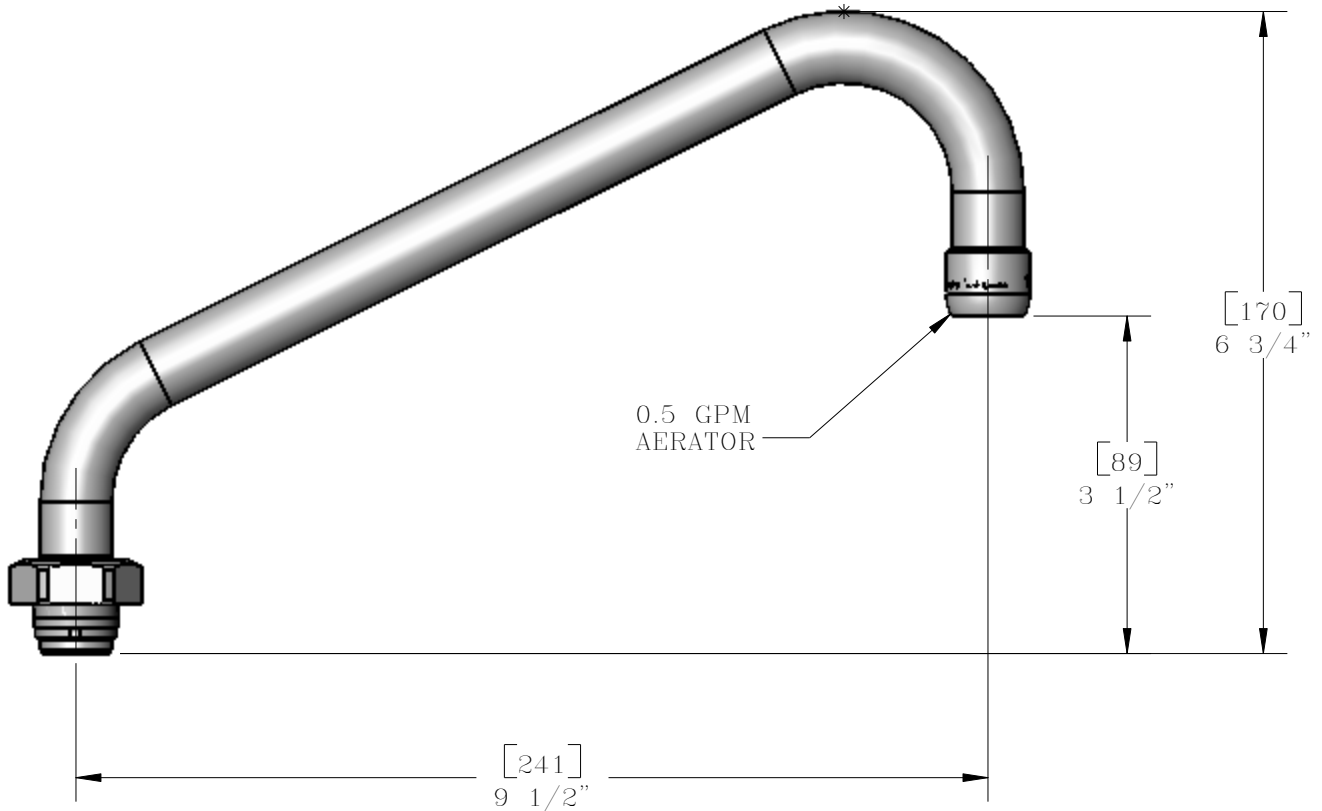

Model Number Q016105-40	Date 08/21/06	Scale 1:2	Drawn DHL	Checked JRM	Approved JHB
----------------------------	------------------	--------------	--------------	----------------	-----------------



Product Specifications:

9 1/2" Swing Spout (SS-D),
w/ 0.5 GPM Female Aerator



T&S BRASS AND BRONZE WORKS, INC.
2 Saddleback Cove, P.O. Box 1088
Travelers Rest, South Carolina 29690
Phone: 800.476.4103 Fax: 800.834.3518, Simi Valley 800.423.0750



REG. #A2601
ISO #9001