



*This Space for Architect/Engineer Approval*

Job Name \_\_\_\_\_ Date \_\_\_\_\_

Model Specified \_\_\_\_\_ Quantity \_\_\_\_\_

Customer/Wholesaler \_\_\_\_\_

Contractor \_\_\_\_\_

Architect \_\_\_\_\_

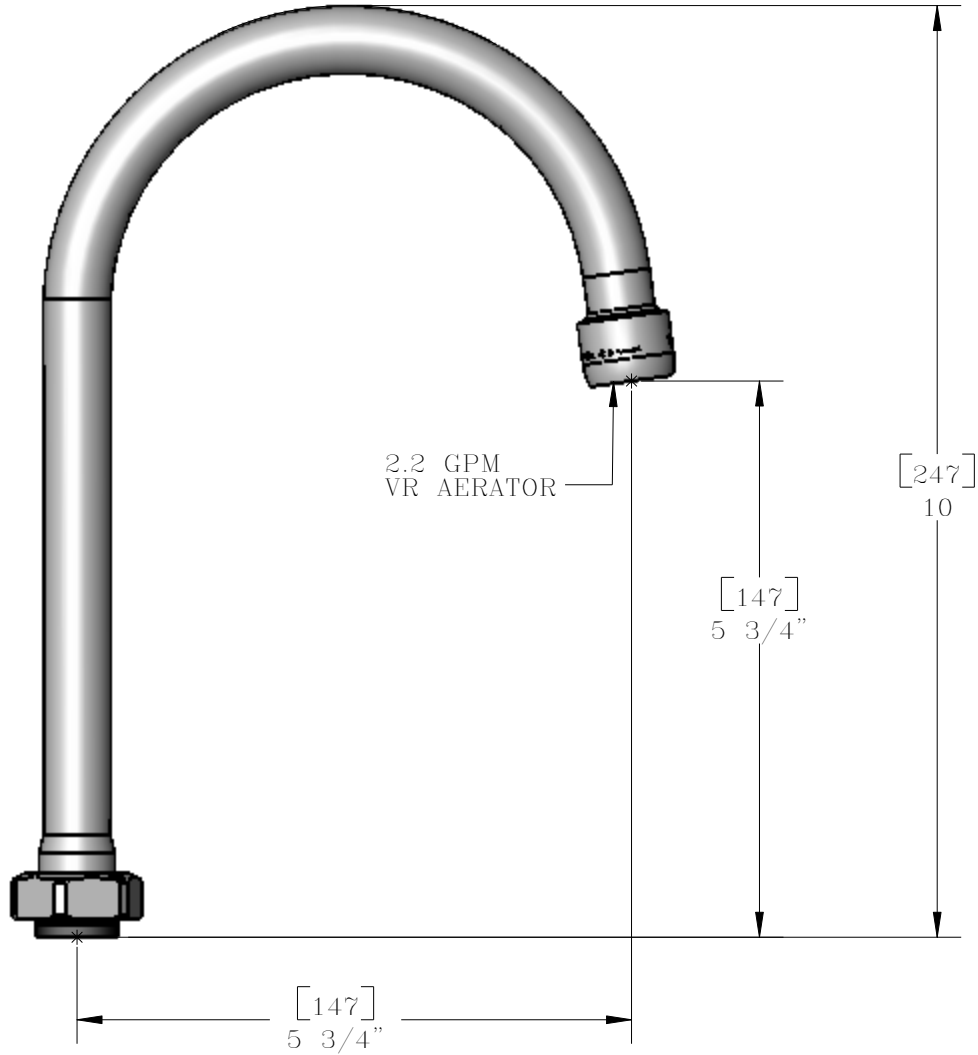

Model Number Q016117-40	Date 08/21/06	Scale 1:2	Drawn DHL	Checked JRM	Approved JHB
----------------------------	------------------	--------------	--------------	----------------	-----------------



Product Specifications:

**5 3/4" Gooseneck (GN-B)  
w/ 2.2 GPM Female VR Aerator**

**T&S BRASS AND BRONZE WORKS, INC.**  
 2 Saddleback Cove, P.O. Box 1088  
 Travelers Rest, South Carolina 29690  
 Phone: 800.476.4103 Fax: 800.834.3518, Simi Valley 800.423.0750



REG. #A2601  
ISO #9001