



T&S BRASS AND BRONZE WORKS, INC.

2 SADDLEBACK COVE / P.O. BOX 1088 / TRAVELERS REST, SC 29690

PHONE 800-476-4103

FAX 864- 834-3518



REG.#A2601
ISO #9001

Model No.

B-7122-C08H

Item No.:

Job Name:

Architect/Engineer Approval:

Notes:

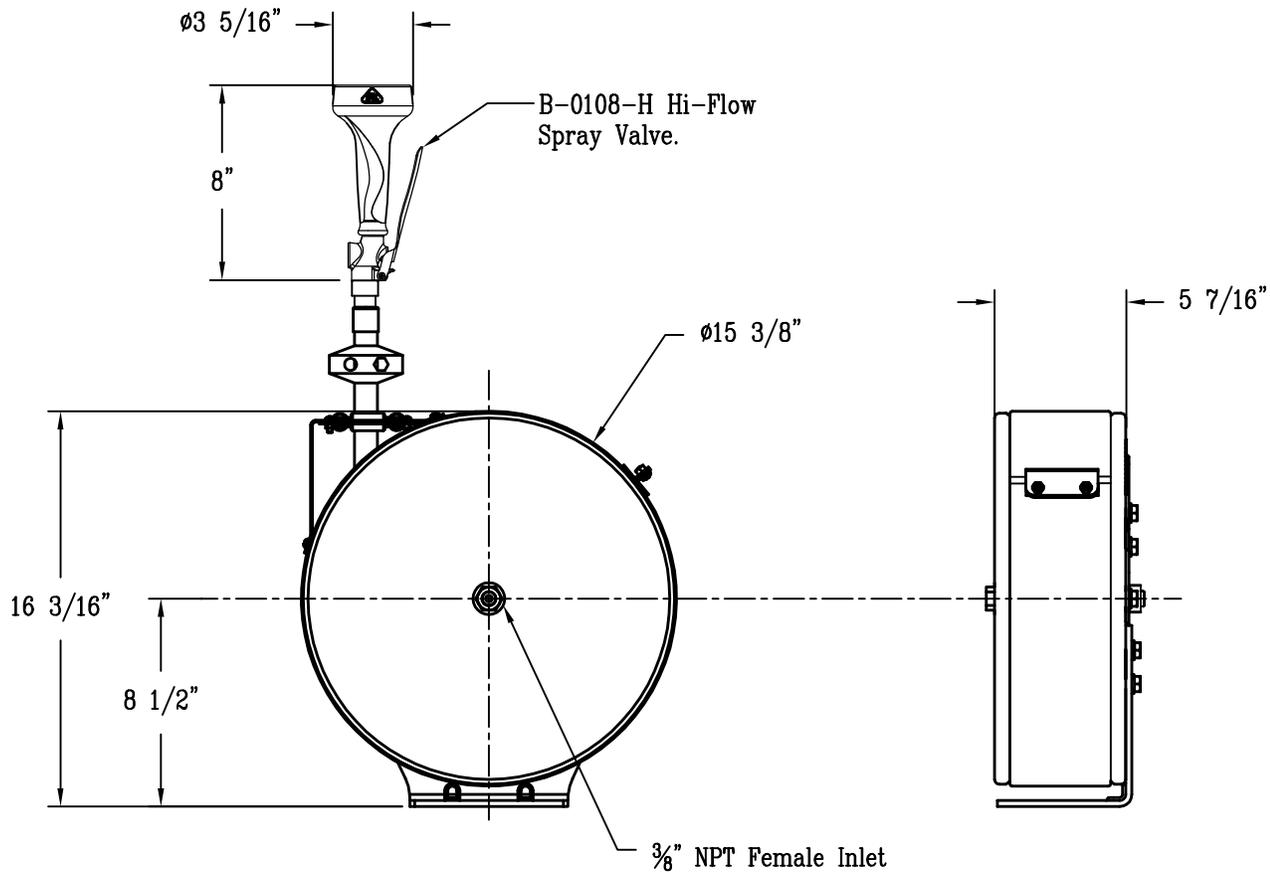

NOTE:
ONCE MOUNTED, INLET
ON LEFT-HAND SIDE

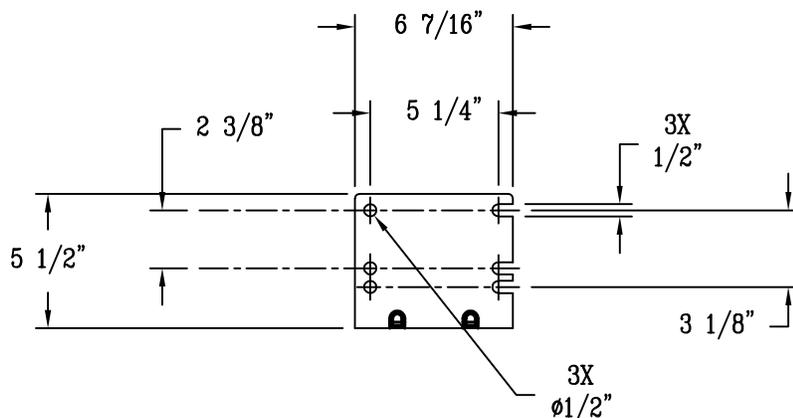

Product Description:
Hose Reel, Closed, Stainless Steel,
30 Ft. of $\frac{3}{8}$ " Dia Blue Hose and
B-0108-H Hi-Flow Spray Valve

Drawn:

WJS

Checked

JRM

Scale:

1:8

Approved

JHB

Date:

05/18/06