



T&S BRASS AND BRONZE WORKS, INC.
 2 SADDLEBACK COVE / P.O. BOX 1088 / TRAVELERS REST, SC 29690
 PHONE 800-476-4103 FAX 864-834-3518



Model No.

EU-AF12

Item No.:

REG.#A2601
ISO #9002

Job Name:

Architect/Engineer Approval:

Notes:

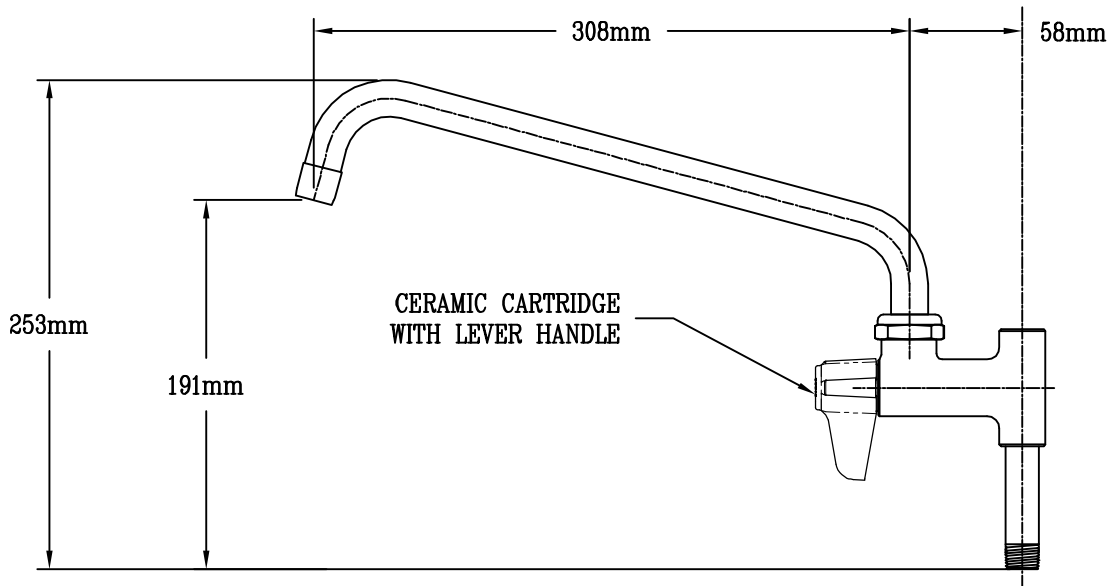

Product Description:
 Add-On Faucet, 308mm (12") Nozzle,
 Ceramic Cartridge, Lever Handle

Drawn:

JKD

Checked

MVW

Scale:

1 : 4

Approved

MVW

Date:

1/16/04