



T&S BRASS AND BRONZE WORKS, INC.
 2 SADDLEBACK COVE / P.O. BOX 1088 / TRAVELERS REST, SC 29690
 PHONE 800-476-4103 - FAX 864- 834-3518



Model No.

MV-2522-31

**RELIABILITY
 BUILT IN**

REG.#A2601
 ISO #9001

Job Name:

Architect/Engineer Approval:

Notes:

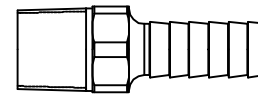
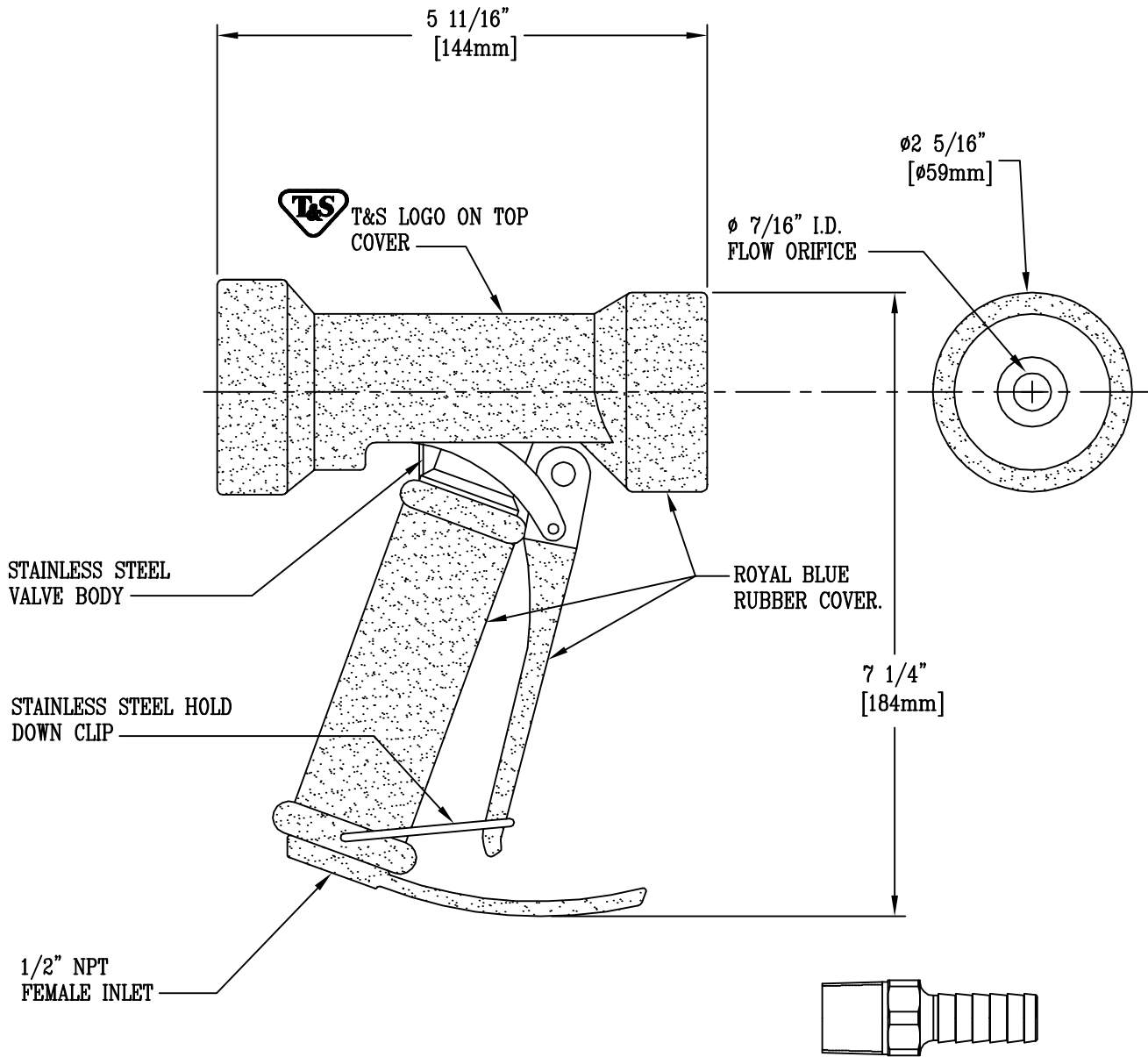

1/2" NPT x 1/2" HOSE BARB CONNECTOR

Product Description:
 STAINLESS STEEL WATER GUN, FRONT TRIGGER,
 7/16" FLOW ORIFICE, RUBBER COVER
 WITH 1/2" NPT x 1/2" HOSE BARB CONNECTOR

Drawn:

LEL

Checked

JKD

Scale:

1 : 2

Approved

MVW

Date:

12/12/02